

A quick T1500 BpBr guide, achieving 5 MHz split.

Snippets from <http://www.repeater-builder.com/motorola/t1500/t1500.html>

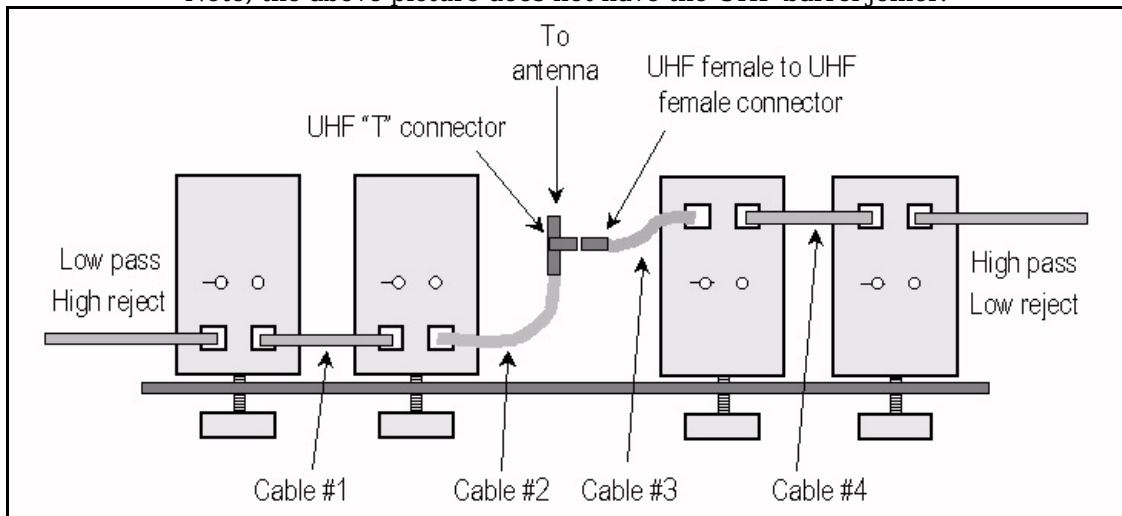

Note, the above picture does not have the UHF barrel joiner.



Cable lengths in inches, from tip of PL259 to tip of PL259 Teflon coax as pictured. Note the UHF barrel used #3

Table from RB website	Cable #1	Cable #2	Cable #3	Cable #4
406-430 MHz	9-3/8	9-3/4	6-3/4	10-1/2
430-470 MHz	8-1/2	8-3/4	5-3/4	9-3/4

In this document from RepeaterBuilder, the pictures are not that clear.
[T1500 manual version "G" dated 01/25/1983](#) 1.3 MB PDF file

From the RB email group: Scale, pictures taken on the outside of a T1500 cavity.
 Capacitive Coupling below

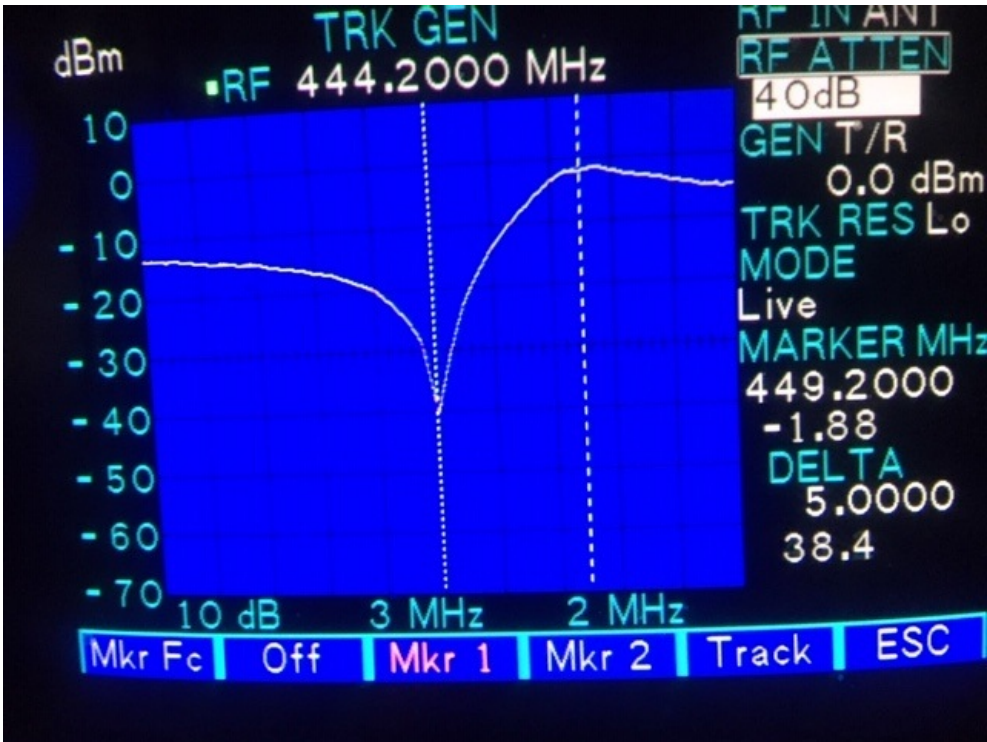
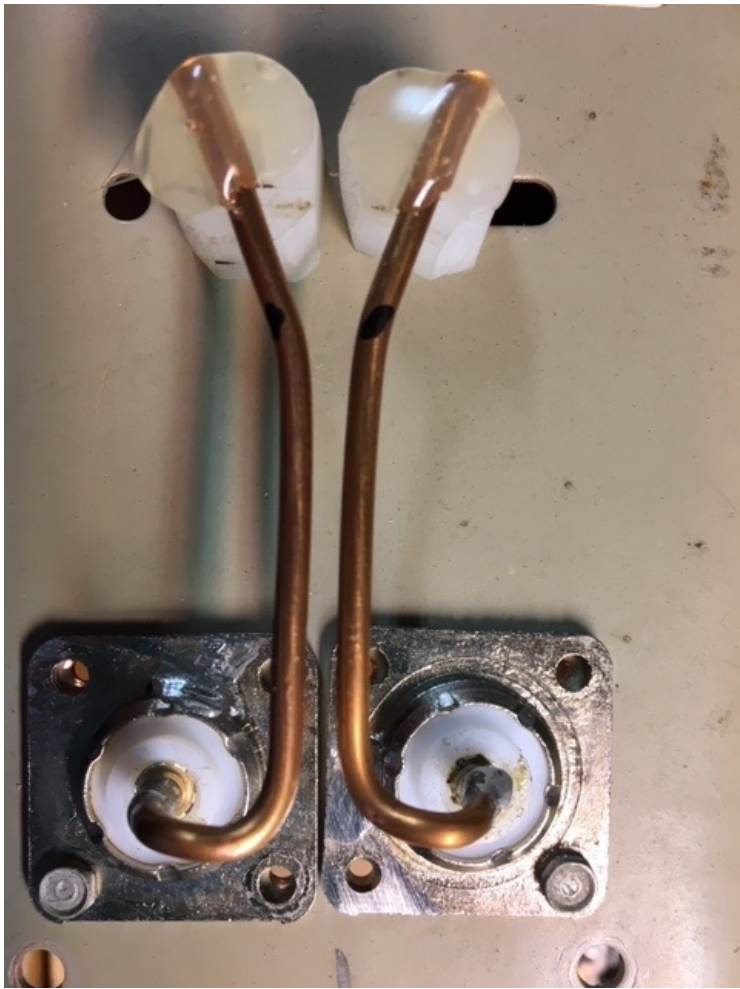

Magnetic Coupling below

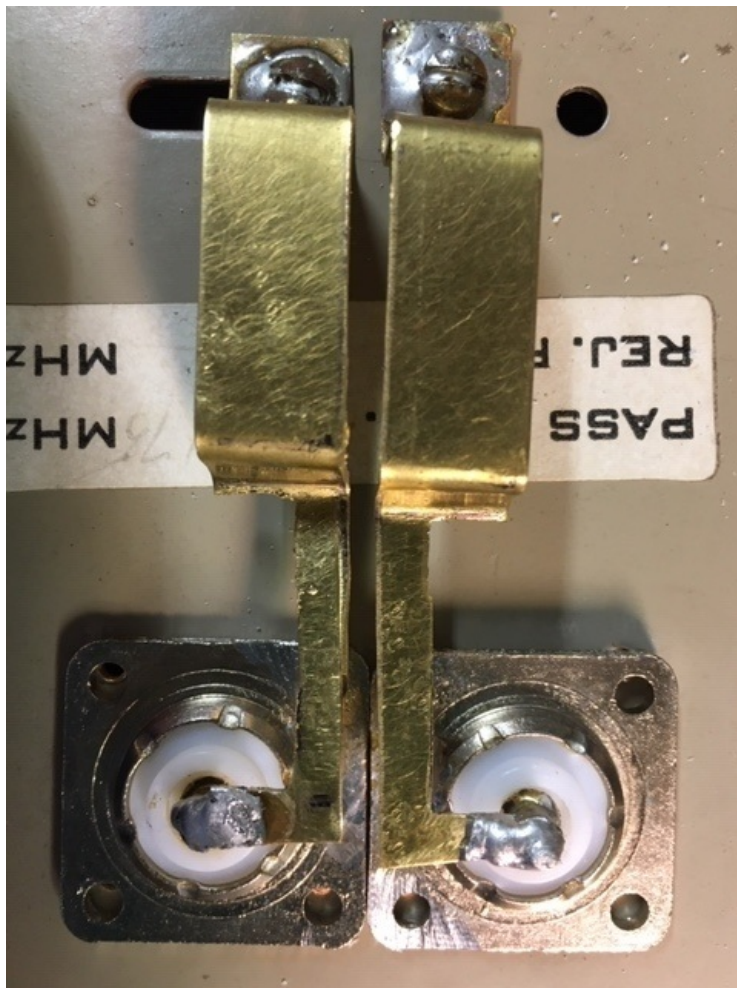

Below from Jim K9AGR

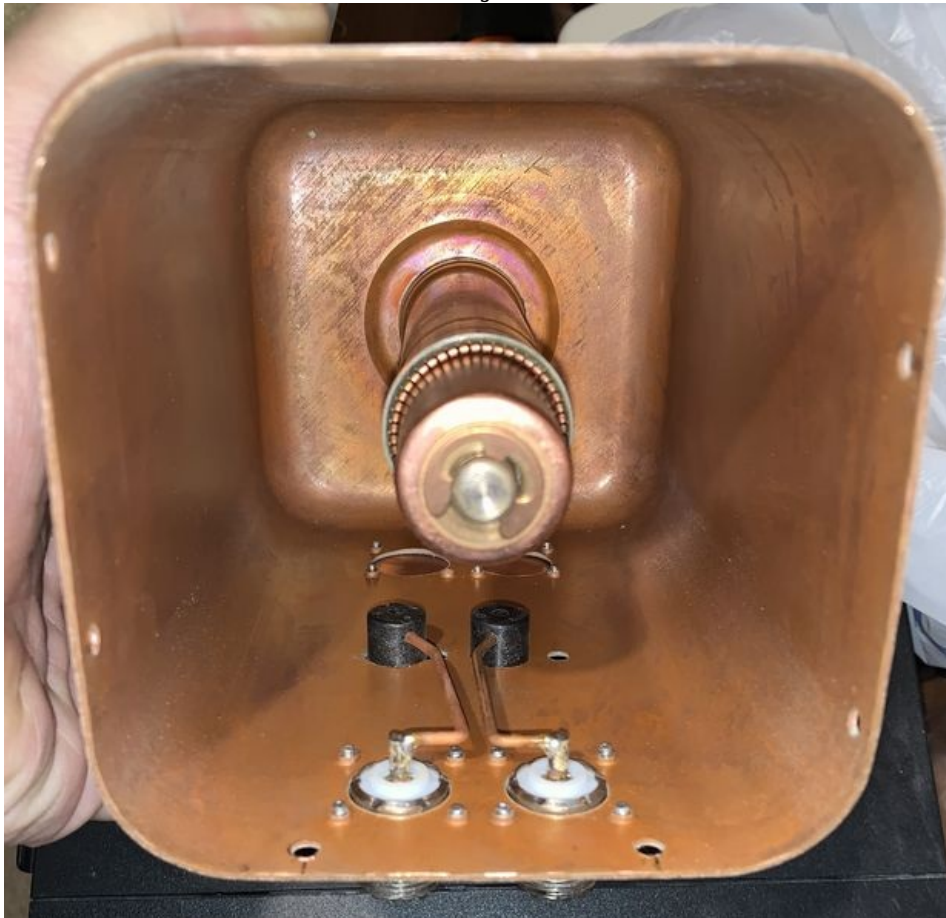

My pictures



This below did not work, I was following a very very poor picture

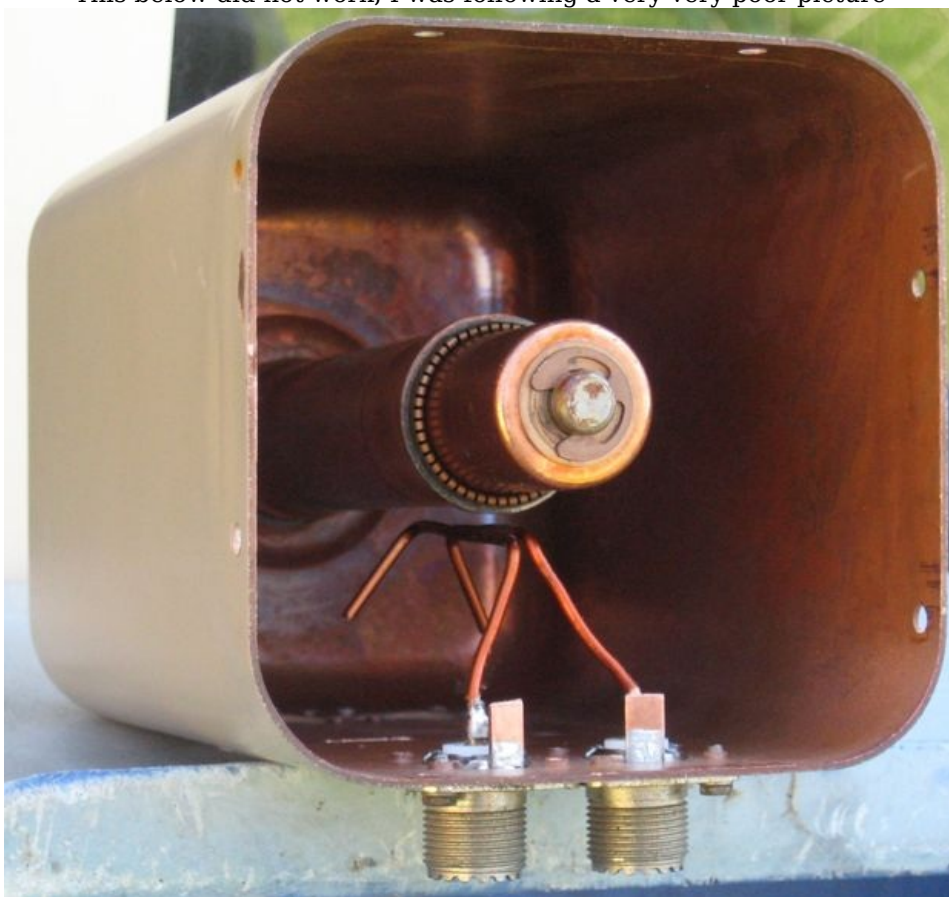

Below some scans of "cap" and "mag", T1500 cavities, 5 MHz blips, 10db / cm.

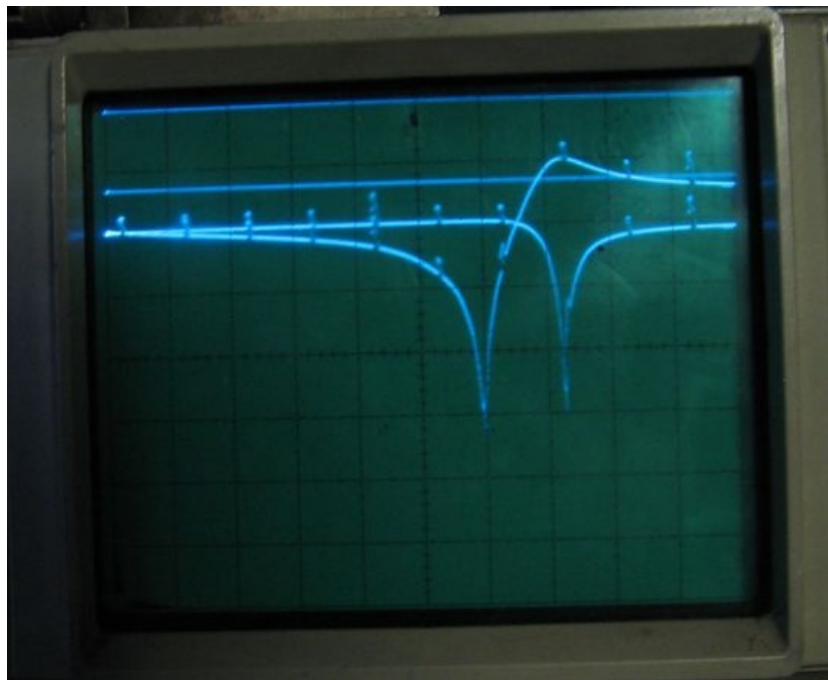

Above Capacitive coupling at the hot end, below Magnetic Coupling.

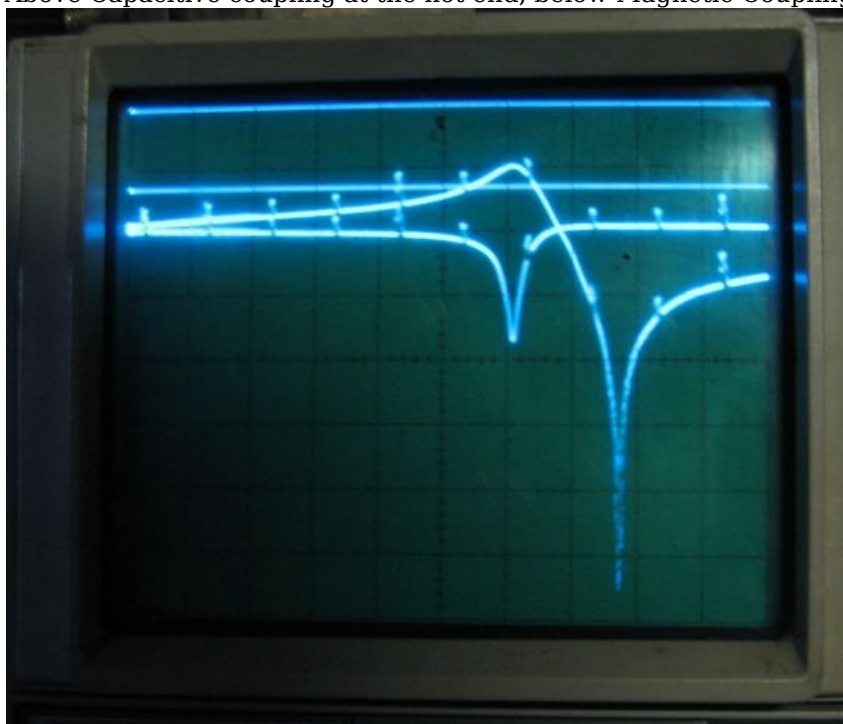

Insertion loss, < 1db.

Back to Magnetic Coupling, it can be done swapping pass-to-notch

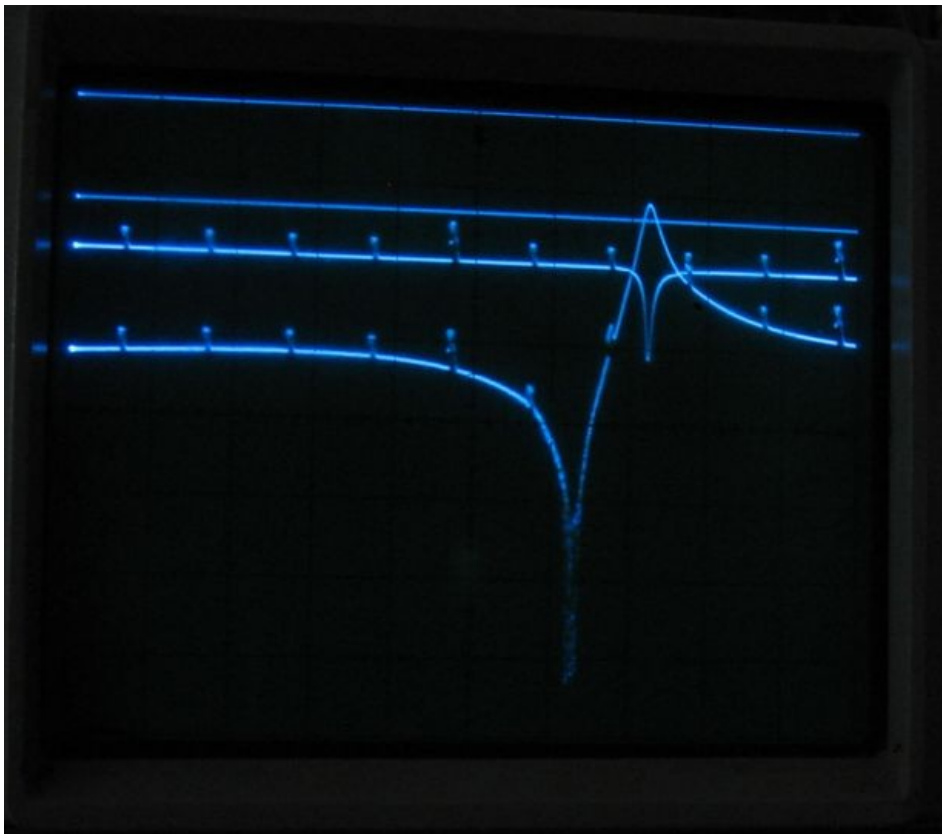

There are two problems here, 1) not adjustable and 2) poor Return Loss evidenced when the ports are swapped. I suspect the magnetic field is not uniform down the cavity and thus the area of one of the loops needs to be increased. The technique has great potential. Or, is this what NOT to do?

I note this has much better 'out of band' rejection, 10db more. Perhaps, a technique for a 6m can.

A side note: The Series Loop and Cap or even the Parallal Loop and Cap both introduce another circuit with a Q factor. And, two notches, possibly loosing 3db in notch depth compared to the 'couple a bit of energy' method, either magnetic or capacitive.

From Jim K9AGR, inside a Decibel Products can

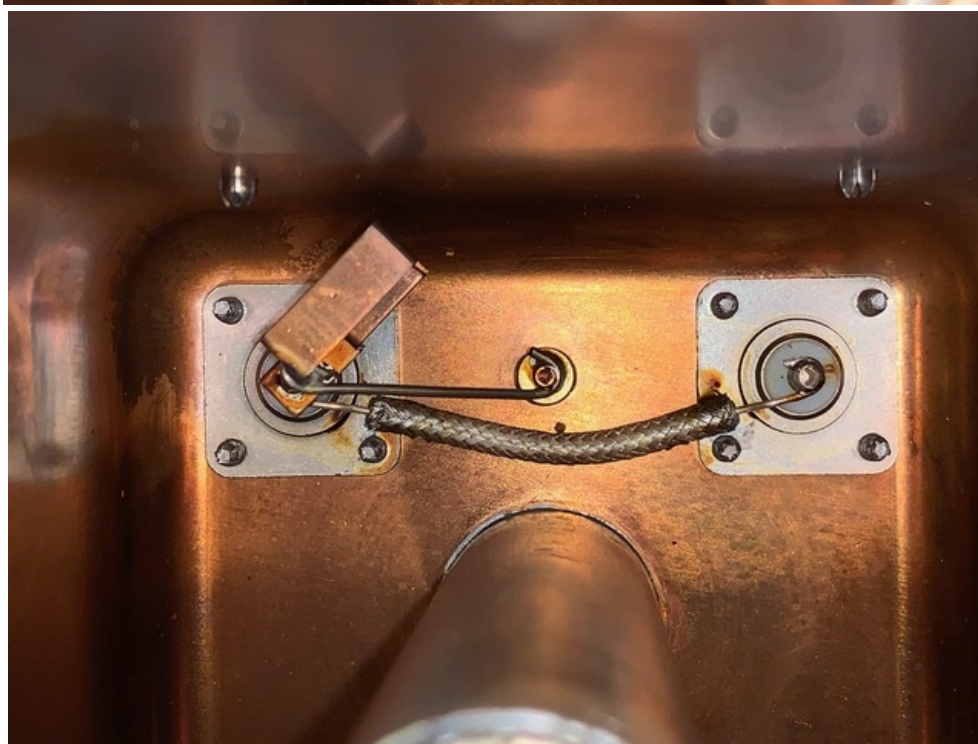
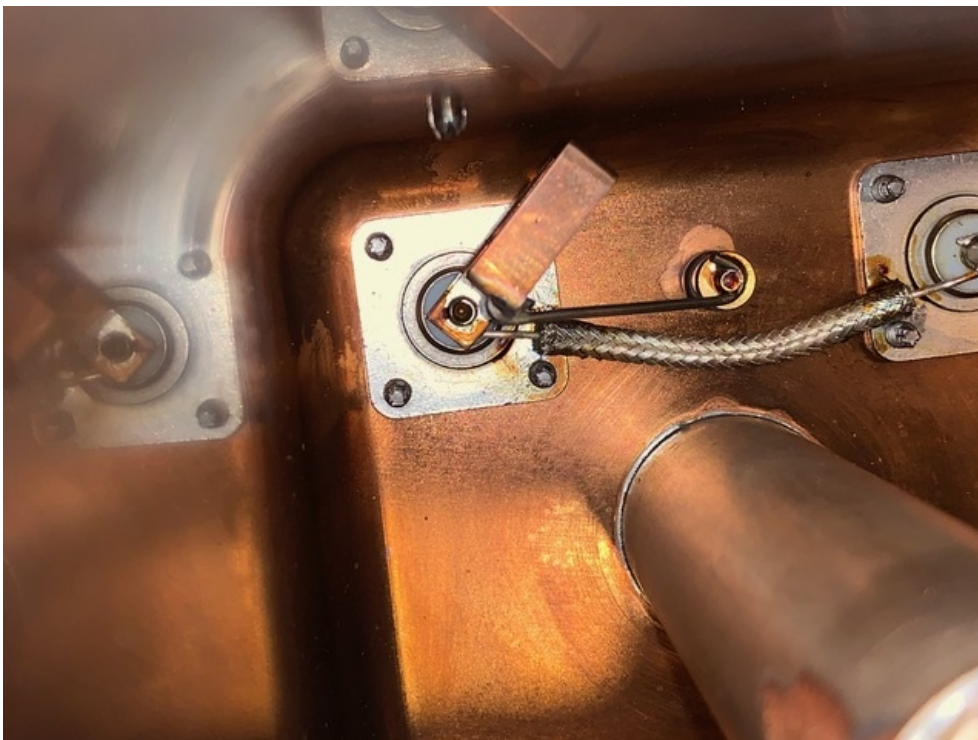

Note the piston trimmer and the coax between connectors.
"T" pieces are problematic, this is a way to avoid them.
Note the coax outer soldered to the connector grounds.
The series resonant loop to GND with coupling to some of the coil.
